

625LBT30 (50mm) - Spindle Series

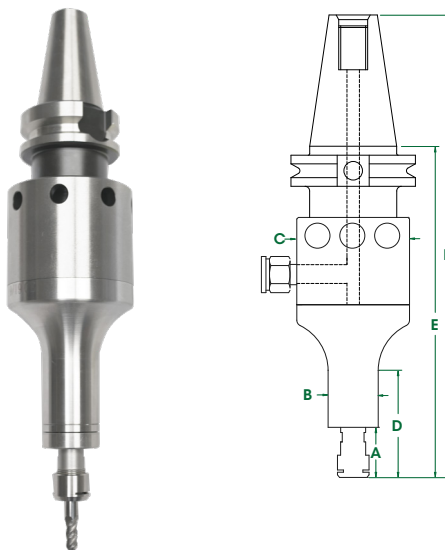

Integration of the popular **BT30** toolholder into the 625S spindle housing delivers constant high speed with ultra low vibration and improves accuracy and rigidity. The powerful **625LBT30 (50mm)** is designed for close workpiece operations and machines with very short z-axis travel. The **625LBT30 (50mm)** delivers patented constant governed high speed operation under load up to 0.50 hp / 0.37 kW at 30,000, 40,000 or 50,000 rpm. At these high speeds, tool coatings achieve the required temperatures to extend endmill life saving money as well as accelerating production. *Air Turbine Spindles®* patented constant governed high speed operation under load cuts faster and cleaner - speeding up cycle times and achieving major savings. Faster cutting with small end mills and drills, finishing or polishing with super accuracy. High speed cutting improves finish quality and accuracy with a fast light pass of your tool. **No Duty Cycle.**

Dimensions



A	1.00" (25mm)	D	2.16" (55mm)
B	1.00" (25mm)	E	6.61" (168mm)
C	2.25" (57mm)	F	8.53" (217mm)

625LBT30 (50mm) Series Spindles

ER11 - 1/4"		ER11 - 6mm	
Speed RPM	Part #	Speed RPM	Part #
30,000	65072	30,000	65073
40,000	65074	40,000	65075
50,000	65076	50,000	65077

Accessories

Model	Part #
High Flow Filter / Regulator / Extractor	30008
Tube 10mm O.D. - 6.5mm I.D. (order by foot)	16508
Hose & Fitting - 10mm O.D. - 6.5mm I.D. - 12'	30043

General Specifications

625LBT30 (50mm)

Speed RPM	30,000 / 40,000 / 50,000
Power Rating hp (kW)	0.40 (0.30) / 0.45 (0.34) / 0.50 (0.37)
Inlet Air Pressure	90 PSI (6.2 Bar)
Air Consumption Idle cfm (l/s)	10.5 (4.9) / 11 (5.2) / 11 (5.2)
Air Consumption Working Flow cfm (l/s)	11 (5.2) - 20 (9.4)
Sound Level	Less Than 78 dBA
Max Shank Capacity	ER 11 - 1/4" (6mm)
Spindle Weight	84 oz (2.38 kg)

Standard Equipment

Spindle, combo filter extractor (p/n #30008), collet, wrenches, hose and fittings, plug (for alternate air inlet not in use) and carrying case. ER 11 collet system (1/4" or 6mm collet standard - other sizes optional).

Oil free 90 psi / 6.2 bar, clean, dry air supply required.

Tel: +1.561.994.0500 • Fax: +1.561.994.8097 • www.airturbinetools.com • info@airturbinetools.com

Do not use couplings / hoses less than 1/4" / 6mm Internal Diameter (ID). Use couplings / hoses with a minimum ID of 6.5mm for 602, 602X and 625 spindles, a minimum ID of 8mm for 625X, 650, 660 spindles and (602, 602X, 625, 625X, 650 and 660 spindles with TMA) and a minimum ID of 10mm for 650X, 660X spindles and (650X and 660X spindles with TMA). Always use a 0.3 micron filter and/or extractor where required and check specified psi or l/s air flow. Use 90 psi / 6.2 Bar clean, dry, oil-free air only. Use eye protection and follow safety instructions. Supply is subject to Air Turbine Tools Inc. terms and conditions of sale and distributor policies in effect for the time being. Subject to availability, change of specifications, price and terms without notice. All specifications approximate. Air Turbine Spindles® is the registered trade name of Air Turbine Tools, Inc. © 2019 Air Turbine Tools, Inc. All rights reserved.