

650XLHSK-A80 (100mm) - Spindle Series

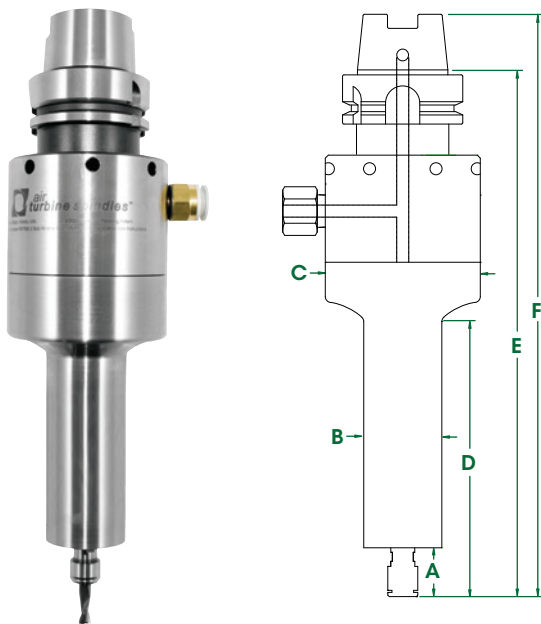

Integration of the popular **HSK-A80** toolholder into the 650XL spindle housing delivers constant high speed with ultra low vibration and improves accuracy and rigidity. Rigid steel construction in one piece with the toolholder also cuts the height of the unit. With *Air Turbine Spindles*® patented double turbine's extra power the 1.4 hp (1.04 kW) motor maintaining stable high speed and torque under load. The powerful **650XLHSK-A80 (100mm)** with the reach for deep pockets, robotic face or edge milling, or furnishing operations at 25,000, 30,000 or 40,000 rpm. Plenty of power to speed up your inches cut per minute. High cutting speeds are maintained at the periphery of your end mill or burr using the the 650's unique governed performance to achieve a faster cycle time, a cleaner finished surface and more production on your CNC. **X = Double Turbine Power. No Duty Cycle.**

Dimensions



A	0.99" (25mm)	D	5.59" (142mm)
B	1.62" (41mm)	E	10.06" (255mm)
C	3.23" (82mm)	F	11.57" (294mm)

650XLHSK-A80 (100mm) Series Spindles

ER11 - 1/4"		ER11 - 6mm	
Speed RPM	Part #	Speed RPM	Part #
25,000	64954	25,000	64955
30,000	64956	30,000	64957
40,000	64958	40,000	64959

Accessories

Model	Part #
High Flow Filter / Regulator / Extractor with 1/2" NPT	30084
Tube 16mm O.D. - 10mm I.D. (order by foot)	16516
Hose & Fitting - 16mm O.D. - 10mm I.D. - 12'	30046

General Specifications

650XLHSK-A80 (100mm)

Speed RPM	25,000 / 30,000 / 40,000
Power Rating hp (kW)	1.2 (0.90) / 1.3 (.98) / 1.4 (1.04)
Inlet Air Pressure	90 PSI (6.2 Bar)
Air Consumption Idle cfm (l/s)	16 (7.56) / 17 (8.02) / 18 (8.49)
Air Consumption Working Flow cfm (l/s)	19 (8.97) - 40 (18.89)
Sound Level	Less Than 78 dBA
Max Shank Capacity	ER 11 - 1/4" (6mm)
Spindle Weight	147 oz (4.18 kg)

Standard Equipment

Spindle, combo filter extractor (p/n #30084), collet, wrenches, hose and fittings, plug (for alternate air inlet not in use) and carrying case. ER 11 collet system (1/4" or 6mm collet standard - other sizes optional).

Oil free 90 psi / 6.2 bar, clean, dry air supply required.

Tel:+1.561.994.0500 • Fax: +1.561.994.8097 • www.airturbinetools.com • info@airturbinetools.com

Do not use couplings / hoses less than 1/4" / 6mm Internal Diameter (ID). Use couplings / hoses with a minimum ID of 6.5mm for 602, 602X and 625 spindles, a minimum ID of 8mm for 625X, 650, 660 spindles and (602, 602X, 625, 625X, 650 and 660 spindles with TMA) and a minimum ID of 10mm for 650X, 660X spindles and (650X and 660X spindles with TMA). Always use a 0.3 micron filter and/or extractor where required and check specified psi or l/s air flow. Use 90 psi / 6.2 Bar clean, dry, oil-free air only. Use eye protection and follow safety instructions. Supply is subject to Air Turbine Tools Inc. terms and conditions of sale and distributor policies in effect for the time being. Subject to availability, change of specifications, price and terms without notice. All specifications approximate. Air Turbine Spindles® is the registered trade name of Air Turbine Tools, Inc. © 2017 Air Turbine Tools, Inc. All rights reserved.